

Almando Multiplay Stereo / Powerlink-Switch



Powerlink output for B&O speakers (even BeoLab 5!)

Stereo inputs for B&O and third-party devices

(via enclosed adapter also signal detection for devices with RCA- or headphone output, e.g. Sonos Connect, Sony TV etc.)

SPDIF input – *only at Almando Multiplay Stereo*

(e.g. for Apple Airport Express, Google Chromecast Audio, Sonos Connect, etc.)

Multiplay Automatic

(audio signal detection, source change with priority circuit, speaker on/off, Auto-Standby)

Bluetooth module for wireless audio streaming

Configuration with the free app **ALMANDO CONTROL**



Installation and operating instructions

ALMANDO

In the digital world of entertainment electronics, there are high-quality devices, technologically sophisticated devices, devices with good design and easy-to-use devices. And there are a few devices that combine all this in order to meet the needs of their users - like devices from almando GmbH. For this, we are taking new and unconventional paths and can rely on many years of experience.

We congratulate you on buying the almando Multiplay Stereo / Powerlink-Switch. The unit is 100% B&O compatible. All active speakers from Bang & Olufsen Lautsprecher with Powerlink input can be connected – even BeoLab 5!

Various devices from Bang & Olufsen and from other manufacturers can be connected to the inputs. The almando Multiplay Stereo / Powerlink-Switch automatically detects whether one of the connected sources is playing and automatically activates the speakers. Once several sources are active simultaneously, an intelligent priority circuit ensures that only the source with the highest priority can be heard.

In order to activate and operate your connected device, you only need a single remote control - the almando Multiplay Stereo / Powerlink-Switch does the rest automatically.

The almando Multiplay Stereo and the almando Powerlink-Switch has a high-quality aptX Bluetooth module integrated. This allows you to play the music from your smartphone or tablet (iOS and Android) wirelessly - the speakers switch on automatically. The almando Multiplay Surround Switch can also be configured and put into operation with a free App.

almando GmbH is not affiliated with Amazon®, Bang & Olufsen®, Google®, Loewe®, Metz®, Sonos®, Sony®, TechniSat®.

All names, logos etc. are registered trademarks of the manufacturers listed in this description.

TABLE OF CONTENTS

ALMANDO	2
TABLE OF CONTENTS	3
TRADEMARKS	4
SAFETY INSTRUCTIONS	5
Information for Users on Collection and Disposal of Old Equipment.....	6
HOW IT WORKS.....	7
STEPS FOR SETUP.....	9
Step 1: Download and Install the App	9
Step 2: Connect the Multiplay / Powerlink- Switch to the Power Grid.....	9
Step 3: Establishing a Bluetooth connection to the smartphone / tablet.....	10
Step 4: Connecting the speakers	10
Connecting speakers individually with a Y-adapter.....	10
Connecting speakers in daisy chain	11
Connecting speakers together with a subwoofer	11
Step 5: Connect the Sources.....	12
Step 6: Start the almando App	13
ALMANDO CONTROL APP	14
Control (Main Screen of the App).....	14
General Settings.....	15
Speaker Settings	17
Input Settings	18
TECHNICAL SPECIFICATIONS.....	19

TRADEMARKS



„Made for iPhone“ and „Made for iPad“ mean that an electronic accessory has been designed to connect specifically to iPhone or iPad, respectively, and has been certified by the developer to meet Apple performance standards.

Apple is not responsible for the operation of this device or its compliance with safety and regulatory standards.

Please note that the use of this accessory with iPhone or iPad may affect wireless performance.

Apple, Apple TV, Apple Watch, iPad, iPad Air, iPad Pro, iPhone, and Lightning are trademarks of Apple Inc., registered in the U.S. and other countries.

tvOS is a trademark of Apple Inc.

App Store is a service mark of Apple Inc.



The Bluetooth word mark and logos are registered trademarks owned by Bluetooth SIG, Inc. and any use of such marks by almando GmbH is under license.

SAFETY INSTRUCTIONS



Connect the device to the power supply using the supplied power cord. A damaged cable must not be repaired.

The operating voltage must match the local mains voltage



Protect the device from moisture and water. Do not operate the unit in rain. The appliance must not be operated near water, bathtub, sink, kitchen sink, wet room, swimming pool or damp rooms. Do not place objects filled with liquid, such as vases, glasses, bottles, etc. on top of the device.

Avoid direct exposure to the sun as well as the immediate proximity of radiators, radiant heaters or similar devices.



If the appliance is suddenly brought from a cold to a warm place, condensation may form inside the appliance. Before switching on, wait until the device has reached room temperature.

To protect the device during a thunderstorm or when it is not supervised or used for an extended period, the mains plug should be pulled. This prevents damage to the device due to lightning strikes and voltage surges in the power supply system.

In case of improper use and by opening the device, the guarantee claim will be extinguished!

Disclaimer of liability:

Almando GmbH is not liable for damage to equipment caused by negligence or improper use. In particular, almando GmbH is not liable for loss of profit or other assets of the buyer. This restriction also applies to the personal liability of employees, representatives and vicarious agents.

Information for Users on Collection and Disposal of Old Equipment

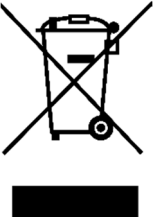

These symbols on the products, packaging, and/or accompanying documents mean that used electrical and electronic products and batteries should not be mixed with general household waste. For proper treatment, recovery and recycling of old products and used batteries, please take them to applicable collection points, in accordance with your national legislation and the Directives 2002/96/EC and 2006/66/EC.

By disposing of these products and batteries correctly, you will help to save valuable resources and prevent potential negative effects on human health and the environment which could otherwise arise from inappropriate waste handling.

For more information about collection and recycling of old products and batteries, please contact your local municipality, your waste disposal service or the point of sale where you purchased the items..

[Information for business users in the European Union]

If you wish to discard electrical equipment, please contact your dealer or supplier for further information.

[Information on Disposal in other Countries outside the European Union]

These symbols are only valid in the European Union. If you wish to discard these items, please contact your local authorities or dealer and ask for the correct method of disposal..

HOW IT WORKS

The almando Multiplay Stereo and the Powerlink-Switch were developed to integrate external devices into a stereo setup with B&O speakers and audio system

Various devices with volume-controlled output can be connected:

- TVs from Bang & Olufsen, Loewe, Metz, Sony, TechniSat
- Audio devices from B&O (e.g. BeoSound 9000, Overture, Essence, Moment, etc.)
- Audio devices from other manufacturers (e.g. Amazon Echo Dot, Apple Airport Express, Google Chromecast Audio, Sonos Connect, etc.)

Here you can see an example of use for Multiplay Stereo:

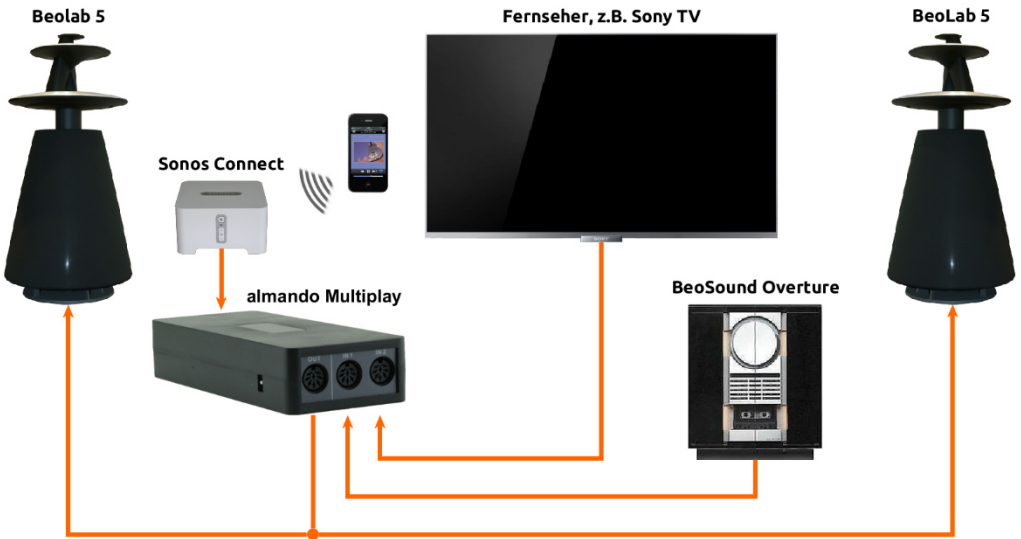

Powerlink signals from connected B&O devices are simply looped through. All other audio signals - whether digital or analog - are converted to a 100% standard B&O Powerlink signal including the trigger voltage required for the B&O loudspeakers (as well as the B&O data signal for BeoLab 5, BeoLab 4500 and BeoLab Penta if required).

The almando Multiplay Stereo and the Powerlink-Switch are not just a Powerlink converter. It's also an automatic source management. To operate one of the connected devices, all you need is the respective remote control and you can also adjust the volume in this way.

The connected sources have different priorities - i.e. even if several sources are active at the same time, you will only hear the one with the highest priority. For example, you can present photos on the TV with music from your audio system, or listen to suggestions from your music service during the halftime of a football match.

The almando Multiplay Stereo and the Powerlink-Switch can be configured individually with a free smartphone app. This allows you to set all parameters such as initial volumes, operating mode (signal detection on/off), automatic generation of the data signal for BeoLab 5 and sound settings such as treble, bass and loudness, etc. - and in some cases even individually for each input. This is how you can adjust your audio setup perfectly to your needs.

You will no longer need the almando Control App in your daily use of your equipment - just the remote control of the device you want to listen to is sufficient. And this is the great strength of the almando device - it does everything for you fully automatically - from recognizing active devices to switching the speakers on and off to smart switching between equally active sources according to predefined priorities.

STEPS FOR SETUP

Step 1: Download and Install the App



Download the free **ALMANDO CONTROL** app from the Apple App Store and install it on your iPhone or iPad.



Download the free **ALMANDO CONTROL** app from the Google Play Store and install it on your Android smartphone or tablet.

Step 2: Connecting the Multiplay / Powerlink- Switch to the Power Grid

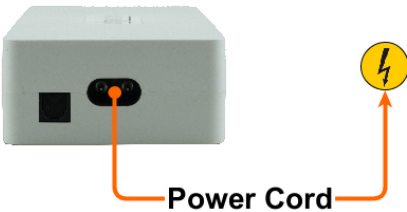

Now connect the almando Multiplay Stereo / Powerlink-Switch to the mains.

Speakers and auxiliary devices may not be connected until later.

Step 3: Establishing a Bluetooth connection to the smartphone / tablet

After connecting the almando Multiplay Stereo / Powerlink-Switch to the mains open the settings in your smartphone, enable Bluetooth, and search for new Bluetooth devices in the area. As soon as a device named "Almando..." is found, click on it and it is paired with the device. You have two minutes to do this after pressing the Bluetooth button on the – during this time, the device is in discovery mode and is visible to your smartphone when scanning for new devices.

This pairing only needs to be done once. If you want to connect another smartphone later, simply disconnect the almando device from the mains for a few seconds and do the same as when pairing with the first smartphone.

Step 4: Connecting the speakers

The almando Multiplay Stereo and the almando Powerlink switch offer an 8-pin DIN socket for connecting Bang & Olufsen loudspeakers. On request, the Powerlink output is also available as RJ45 socket for the new generation B&O speakers (e.g. BeoLab 18).

Connecting speakers individually with a Y-adapter

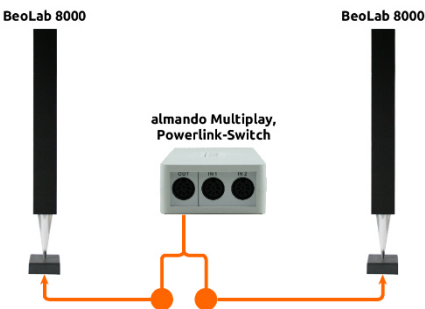

To connect your B&O speakers individually, you need a Powerlink-Y-Adapter (#210111), because the almando Multiplay and the almando Powerlink-Switch have only one output socket.

This example shows the connection of a pair of BeoLab 8000.

Connecting speakers in daisy chain

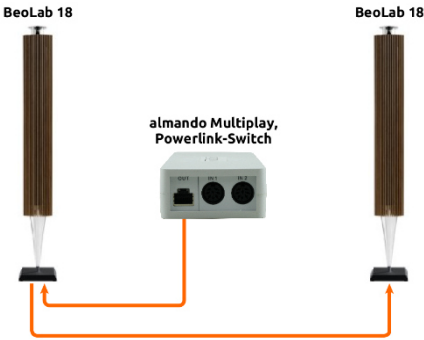

If your B&O speakers each have two Powerlink sockets, you can also loop the Powerlink cables through (daisy chain) - from one speaker to the next, like a chain of lights.

Here you can see the connection of a pair of BeoLab 18.

Connecting speakers together with a subwoofer

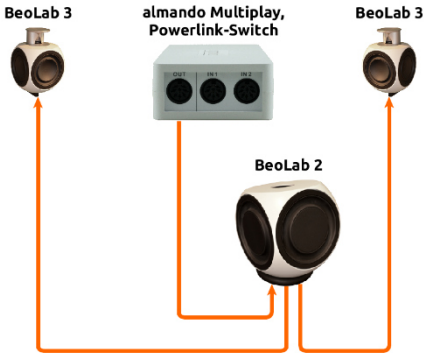

You can also connect a subwoofer. The subwoofer itself has two further Powerlink sockets to which you connect the pair of speakers.

The figure shows the connection of one BeoLab 2 and one pair of BeoLab 3.

Step 5: Connecting the Sources

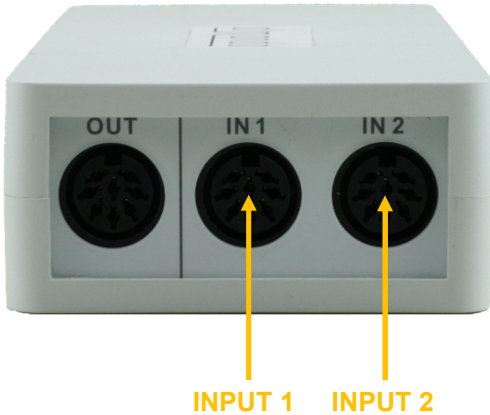

INPUT 1 – POWERLINK (8pin DIN)

Here you can connect a Bang & Olufsen system (BeoSound 9000, BeoSound Overture) with a classic Powerlink cable.

Newer B&O systems (such as BeoSound Essence, BeoSound Moment) can also be connected - this input is also available as an RJ45 socket.

INPUT 2 – POWERLINK (8pin DIN)

Here you can also connect Bang & Olufsen devices. In addition, it is also possible to connect devices from other manufacturers using the enclosed DIN RCA adapter. In signal detection mode, no switching voltage is required (applies only to input 2, not to input 1).

As soon as a signal is present, it is converted into a Powerlink signal with switching voltage.

If the source no longer supplies a signal (e.g. if it is muted or switched off), an intelligent circuit ensures that the Powerlink signal is turned off and the B&O speakers go into standby. This is necessary e.g. for longer breaks between audio books or gives you enough time to select the next songs for playback in your music archive.

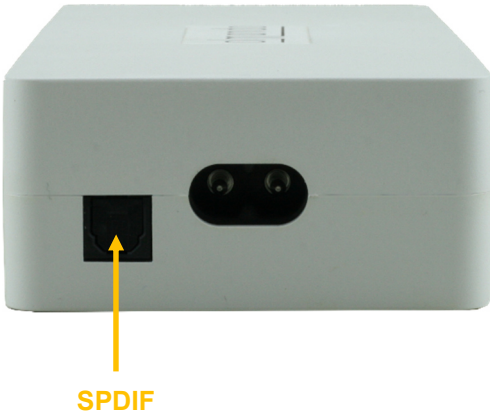

SPDIF (only at Multiplay Stereo)

If possible, use only audio devices with a volume controllable optical output such as Apple Airport Express, Google Chromecast Audio, Sonos Connect, etc. The necessary fiber optic cables are included in delivery.

The almando Multiplay Stereo is also able to convert PCM stereo signals from video devices via SPDIF (e.g. Blu-ray players, various televisions, AV receivers, Apple TV) - however, these sources CANNOT be volume controlled with their own remote control. The volume control should always be done with the Almando App, which is of course not very comfortable.

Step 6: Starting the almando App

If you are connected to the almando device via Bluetooth, you can start the app and get to the start page of the app.

ALMANDO CONTROL APP

Control (Main Screen of the App)

The main screen of the App is divided into these sections:

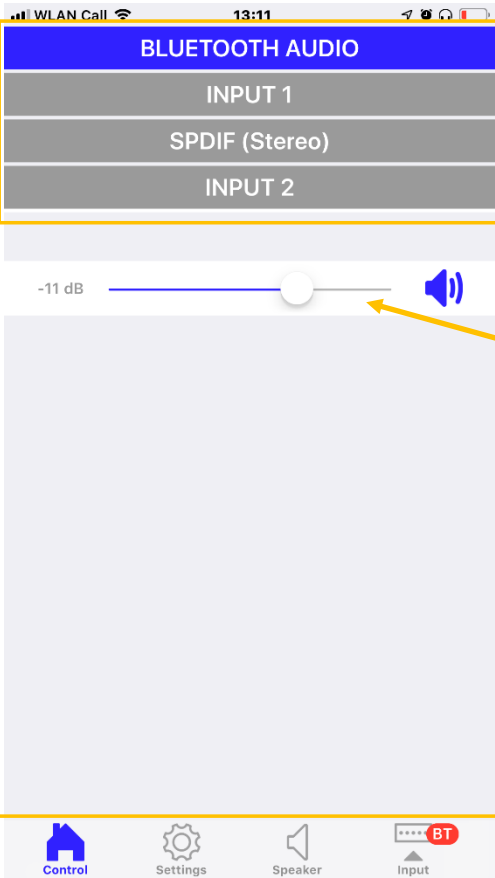

In the top area all available inputs are listed in the order of their priority. The currently active input is shown in color. If several inputs are active at the same time, the upper priority takes precedence.

In the area below you will find the volume control. The volume value of the currently active input is shown on the far left. And if the volume control with the app in the input settings has been activated for this input, a volume control slider and a mute button are available to the right.

At the bottom, you will find the toolbar to navigate to the other pages of the app, which are described individually on the next pages.

General Settings

On this page you make general settings and have the possibility to reset the device to the factory defaults or to update the firmware.

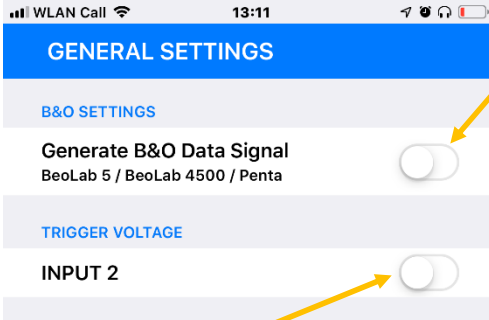

Here you determine whether data signals will be sent to the B&O speakers (input data from connected B&O devices or data generated by the almando Decoder itself for third-party devices). This is only necessary if BeoLab 5, BeoLab 4500 or BeoLab Penta are connected. Otherwise the generation of the "data signal" should remain deactivated (default setting).

Usually a non-B&O device is connected to this input (INPUT 2) e.g. Sony TV, Sonos Connect, etc., which is operated with automatic audio signal detection (then this switch remains deactivated as in the delivery state).

If a device providing trigger voltage is connected to this input (e.g. a B&O system such as BeoSound 9000, BeoSound Overture, etc.), you should activate this switch. However, there are two exceptions: BeoSound Essence and BeoSound Moment - here please leave this function deactivated, the input will then be operated with audio signal detection.

Recommendation: if INPUT 2 is operated with signal detection (trigger voltage INPUT 2 is not activated), set the gain to -10 dB in the input settings for INPUT 2 and switch back to the main page of the app (control) so that this value remains permanently stored.



If no devices are connected to certain inputs, they can be deactivated here. They will then be hidden on the main screen of the app. This setting can be undone later at any time.

If only one device is connected to the analog inputs, you can establish a direct ground connection between the input used (INPUT 1 or INPUT 2) and the output.

Click on this button to get to the page for displaying and updating the firmware. If a new firmware for your device is available on the almando server, then this line is colored red and a badge on the navigation icon for the settings displays the message "FW".

Here you can reset your device to factory defaults.

If you want to restart your device, you can click here - this has the same function as disconnecting the device from the mains for a few seconds.

If you need information on installing or operating your device, you can download the instruction manual as a PDF and have it displayed by clicking here this button.

Further information can be found on our website, which you can visit by clicking on this button.

Speaker Settings

This page is used to configure the speakers.

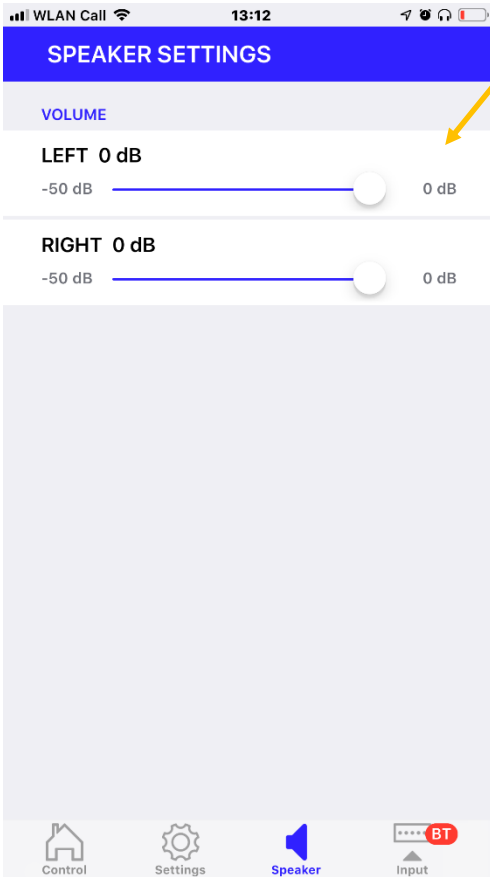

With these sliders you can adjust the individual volume for both speakers (LEFT and RIGHT). And these settings can be made separately for each input (BLUETOOTH, SPDIF, INPUT 1 and INPUT 2).

IMPORTANT: The connected device must be playing and the corresponding input must be active for the level setting to be correct.

Input Settings

For each individual input you can make various settings separately. To do this, just turn on the source player at the input you want to configure and start playback.

The active input is highlighted in its color, and a badge on the navigation icon for the input settings in the bottom right also shows its name. Click on this navigation icon and you will be taken to a new page where you can make the specific settings for exactly this input – for example BLUETOOTH (BT) shown here.

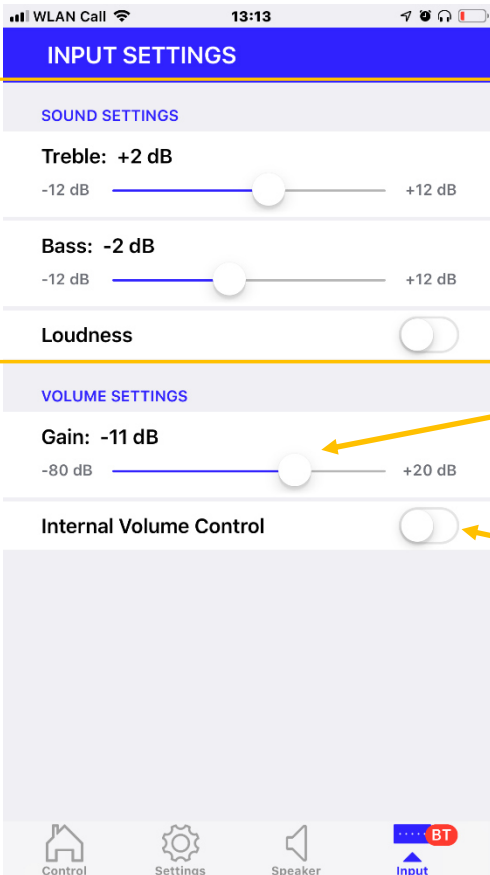

For the sound settings, you can raise or lower the level of treble and bass by up to 12 dB each. And you also have the option to enable or disable loudness.

Use this slider to set the channel-specific volume for the device connected to the active input - level (gain) respectively start volume.

The volume control function with the almando APP should only be activated in exceptional cases. This is only necessary if the connected device does not have its own volume control (e.g. turntable).

TECHNICAL SPECIFICATIONS

Powerlink signals	8pin DIN inputs and output are 100% B&O compatible (also to BeoLab 5)
Inputs	- 2 x DIN 8pin / B&O Powerlink - 1 x SPDIF (<u>only at Multiplay Stereo</u>)
Output	- 1 x DIN 8pin / B&O Powerlink Stereo
Power Supply	100-240 V, 50/60 Hz
Measurements	171 x 72 x 34 mm (B x T x H)
Weight	0,3 kg
Color	Plastic enclosure available in black and white
Warranty	3 years
Accessories included	- Power Cord
Accessories included (<u>only at Multiplay Stereo</u>)	- Optical cable: Toslink <-> Toslink, length 1m (e.g. for Sonos Connect) - Optical cable: Toslink <-> 3,5mm, length 1m (e.g. for Apple Airport Express)
Accessories sold separately	- Optical cables (several lengths) - Powerlink-Y-Adapter - Powerlink cables (several lengths) - Powerlink RJ45 adapter cables (several lengths)

www.almando.com